



# Quadro





# quadro



## Design

**Quadro** è un sistema di segnaletica a superficie piana, per esterni ed interni, con elementi modulari ed intercambiabili.

Presenta un assortimento completo con tipologie a totem e su pali per esterno, a parete, a bandiera, sospese e autostabili, il tutto con una rilevante variabilità dimensionale.

Elemento caratterizzante è l'elegante cornice perimetrale che può essere proposta in diverse colorazioni.



## Progettato per durare nel tempo

I segnali sono realizzati in alluminio perché durevole, leggero e preciso nella produzione dei profili.



## Semplice da aggiornare

L'intercambiabilità dei listelli in alluminio estruso assicura flessibilità e facilità di aggiornamento. I testi e la grafica sono realizzati in pellicola vinilica adesiva.

È prevista la "gestione carta" nei formati unificati DIN, con grafica stampata su cartoncino per essere gestita autonomamente.



## Antimanomissione

I listelli in alluminio estruso sono inseriti a scatto all'interno della cornice perimetrale del segnale e possono essere rimossi solo con attrezzo fornito in dotazione.

## Design

***Quadro** is a system of flat signs, suitable for indoor and outdoor use, with modular and interchangeable parts.*

*It offers a complete range of outdoor totems and posts and wall mounted, projecting, hanging and freestanding signs, each with a considerable variability of size.*

*Notable its elegant perimeter frame that can be provided in different colours.*

## Designed to last

*The signs are made in aluminium as it is durable and light, suitable for obtaining precise profiles.*

## Easy to update

*The possibility of interchanging the extruded aluminium panels ensures flexibility and easy updating of information.*

*The text and graphics are realised in adhesive vinyl film.*

*Furthermore, it is designed for the use of paper inserts in standard DIN typeface format, with graphics printed on the paper that can be managed autonomously.*

## Anti-tampering

*The extruded aluminium panels are inserted by simply clicking them into the perimeter frame of the sign and can be removed only with the specific tool provided.*

FOUR



VILLAGGIO SPORTIVO

Piscina Olimpionica  
Piscina Bambini  
Trampolini - Scivoli

Basket  
Pallavolo - Pallamano  
Tennis

Calcio  
Tiro con l'arco  
Golf

SkatePark  
Palestra  
Centro Benessere





 VILLAGGIO  
SPORTIVO

 PISCINE



 GOLF



 PALESTRA















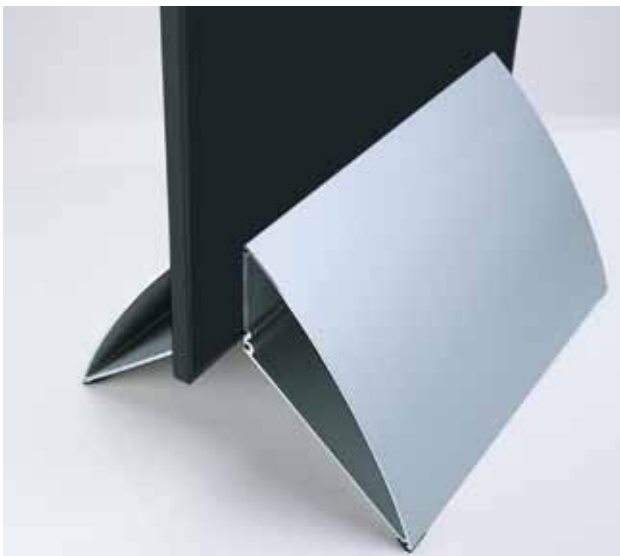

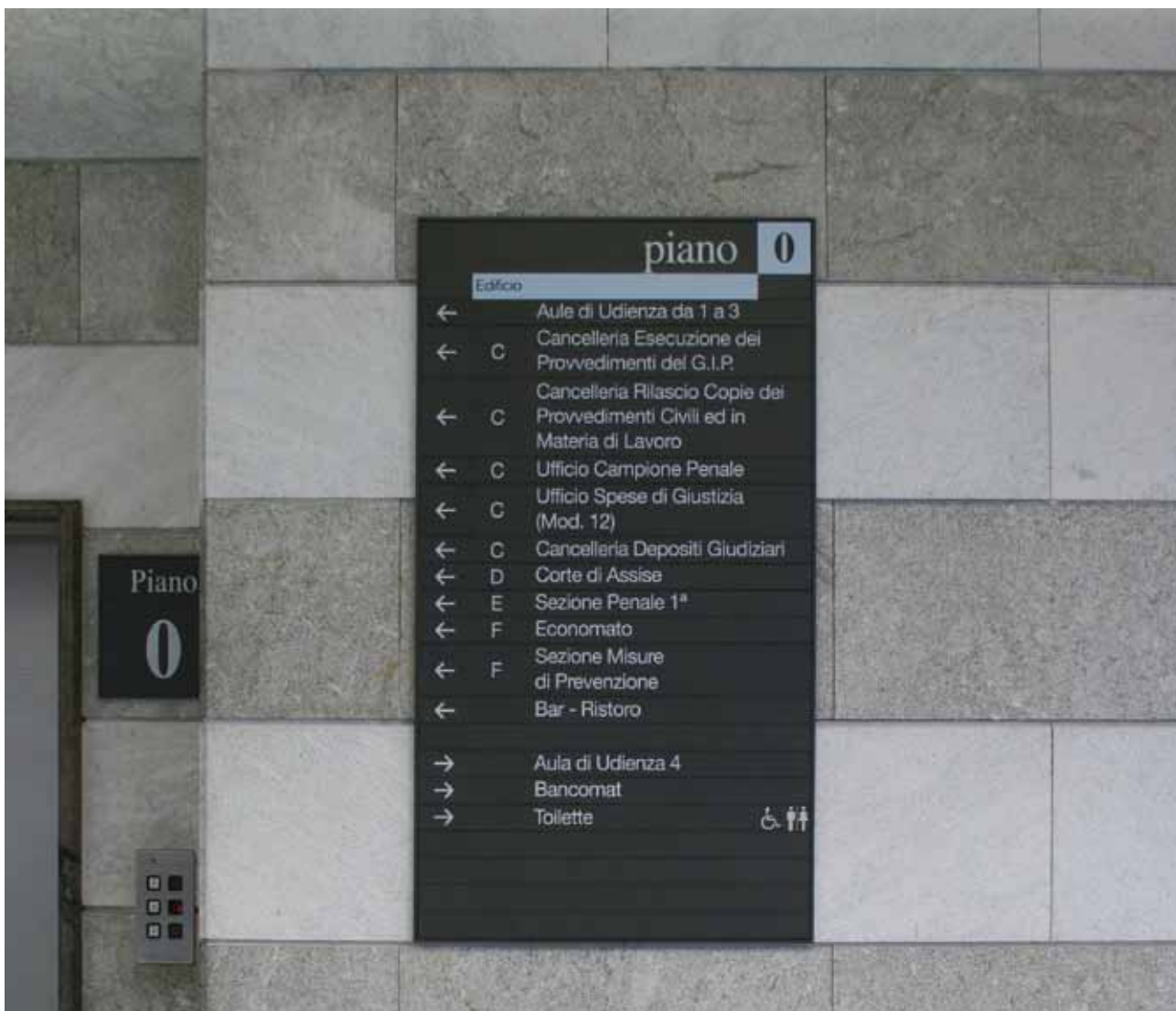



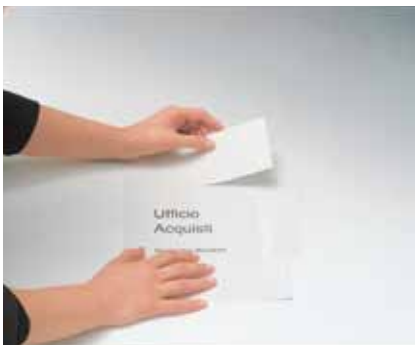
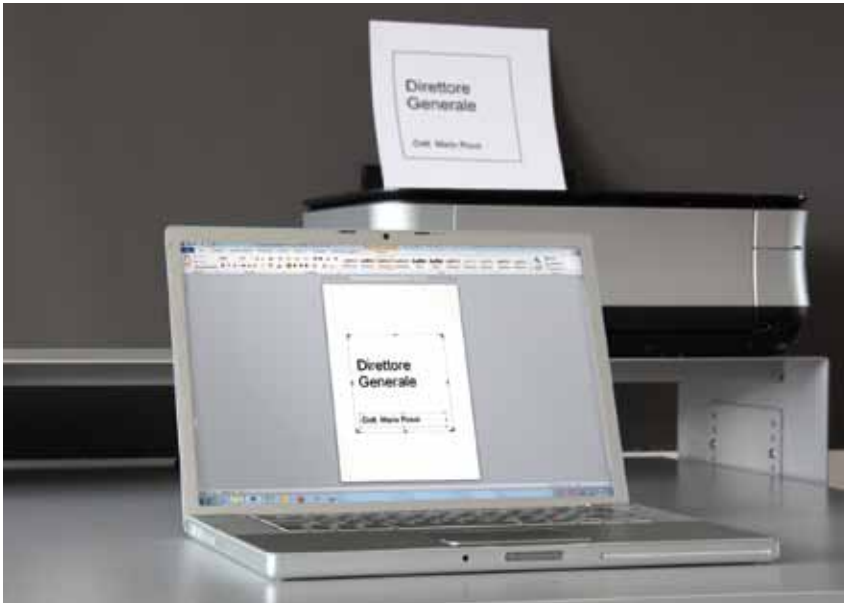

## CARATTERISTICHE TECNICHE TECHNICAL CHARACTERISTICS

QUADRO è un sistema di segnaletica a superficie piana, di produzione standardizzata e realizzata industrialmente. I segnali sono caratterizzati da una cornice perimetrale collegata agli angoli da nodi a squadra in pressofusione di zama. La superficie informativa è ottenuta con listelli in alluminio estruso disponibili nelle altezze 24, 36, 48, 72, 96, 144 mm, o con lamiera di alluminio sp. 1,2 mm nel caso di altezze maggiori di 144 mm. Listelli e lamiera sono agganciati a scatto su una piastra strutturale in alluminio estruso, non visibile dall'esterno, con clip in nylon a passo modulare che garantiscono la perfetta distanza tra i moduli. È prevista la "gestione carta" nei formati unificati DIN, con grafica stampata su cartoncino per essere gestita autonomamente. Ogni segnale presenta angoli e spigoli arrotondati nel rispetto delle norme antinfortunistiche e di sicurezza.

*QUADRO is a system of flat signs, industrially produced in a standard design. The signs have a perimeter frame joined together by means of corners in Zamak die casting. The information sign is made up of extruded aluminium panels, available in heights of 24, 36, 48, 72, 96 and 144 mm, or in aluminium sheet of 1.2 mm width if the sign is higher than 144 mm. The panels and sheets are clipped to an invisible extruded aluminium structural plate, using a nylon clip with modular coupling that guarantees a perfect distance between the modules. The system is designed for the use of paper inserts in standard DIN typeface format, with graphics printed on the paper that can be managed autonomously. Each sign has rounded edges and corners conforming to safety and accident prevention regulations.*



### MODULARITÀ - MODULE TYPES

Le dimensioni dei segnali si sviluppano secondo multipli del modulo base 12 mm. I listelli in alluminio estruso sono disponibili nelle altezze 24, 36, 48, 72, 96, 144 mm.

*The sizes of the signs increase in multiples of 12 mm. The extruded aluminium panels are available in heights of 24, 36, 48, 72, 96 and 144 mm.*



### ANTIMANOMISSIONE - ANTI-TAMPERING

Il sistema è progettato per garantire l'utilizzatore contro eventuali manomissioni non controllate o non abilitate, escluso ovviamente atti vandalici o azioni similari. I listelli in alluminio estruso sono inseriti a scatto all'interno della cornice perimetrale del segnale e possono essere rimossi solo con attrezzo fornito in dotazione.

*The system is designed to guarantee the user against any possible tampering that is not controlled or authorised, obviously excluding acts of vandalism or similar acts. The extruded aluminium panels are inserted by clipping them into the perimeter frame of the sign and so removal is only possible with the specific tool provided.*



### MATERIALI - MATERIALS

Profili estrusi: alluminio Lega EN AW 6060  
Lamiere: alluminio EN AW 3105 spessore 1,2 mm  
Clip di aggancio: PA66 - Polyamide (Nylon) 66  
Protezione trasparente "gestione carta": Policarbonato spessore 2 mm

*Extruded profiles: EN AW 6060 aluminium alloy*

*Sheets: EN AW 3105 aluminium, 1.2 mm thick  
Fastening clip: PA66 - Polyamide (Nylon) 66  
Transparent paper inserts protective cover: Polycarbonate 2 mm thick*



### GRAFICA - GRAPHICS

È realizzata in pellicola vinilica adesiva ad alta aderenza e stabilità dimensionale, in stampa digitale con laminazione con filtro UV, su cartoncino 120 grammi nei segnali con "gestione carta".

*Realised in adhesive vinyl film with high adhesion and dimensional stability, by digital print with UV filter lamination, on 120 grams paper in the paper insert signs.*



### ANODIZZAZIONE E VERNICIATURA ANODISING AND PAINTING

L'anodizzazione in colore naturale argento chimico ed in elettrocolore nero è eseguita secondo i criteri del marchio di qualità europeo "QUALANOD". La verniciatura è eseguita nel pieno rispetto delle direttive tecniche del marchio di qualità europeo "QUALICOAT", con smalto termoindurente privo di solventi, a base di resine poliestere e pigmenti selezionati atossici completamente privi di piombo, cromo e zinco. Le superfici presentano una finitura senza riflessi, con brillantezza da 30 a 50 gloss.

*The anodising process is carried out both in natural chemical silver and in black electro colour in conformity with the "QUALANOD" European quality mark. Painting is carried out in full respect of technical directives of the "QUALICOAT" European quality mark, using solvent free, thermo-indurent enamel with a base of polyester resin and selected non-toxic pigments completely free of lead, chrome and zinc. The surface has a non-reflexive finishing with a gloss level ranging from 30 to 50 units.*



### CERTIFICAZIONE AL FUOCO FIRE SAFETY CERTIFICATION

I materiali sono certificati Classe 1 di reazione al fuoco.  
*Materials are certified Class 1 in fire safety.*



### MANUTENZIONE E PULIZIA MAINTENANCE AND CLEANING

I prodotti non necessitano di particolari interventi di manutenzione. Per la pulizia delle superfici utilizzare esclusivamente acqua e sapone neutro. È raccomandabile usare un panno morbido avendo cura di risciacquare e asciugare accuratamente. Le macchie di piccole dimensioni sulle superfici in alluminio possono essere pulite con acqueragia minerale o alcool denaturato, mentre quelle causate dall'assorbimento di sostanze da parte della vernice non sono eliminabili. Evitare l'uso di prodotti contenenti sostanze abrasive o solventi.

*The products do not need any particular maintenance. Use only water and neutral soap to clean the surface. Use of a soft cloth and rinsing and drying well is advised. Small marks on the aluminium surface can be cleaned with white spirit or denatured alcohol, while marks caused by the absorption of substances on the paint cannot be removed. Avoid using products that contain abrasive substances or solvents.*



## TIPOLOGIE TYPES OF SIGNS

### TOTEM PER ESTERNI TOTEM FOR OUTDOOR USE

Struttura monolitica realizzata con montanti laterali in alluminio estruso a forte spessore, profondità 150 mm con sezione a "U", collegati fra loro da profili in alluminio estruso.

Superficie informativa in lamiera di alluminio spessore 2 mm pressopiegata sui quattro lati, e/o con listelli intercambiabili in alluminio estruso previsti dal sistema.

Installazione con piastre in acciaio zincato a caldo su apposito dado di fondazione in cls opportunamente dimensionato.

*Monolith structure with robust extruded aluminium lateral profiles, depth of 150 mm with a "U" section, joined by means of extruded aluminium profiles.*

*The information panel is in aluminium sheet, 2 mm thick, press-folded on its four sides, and/or with extruded aluminium interchangeable panels as provided for by the system.*

*Installation with hot zinc plated steel plates secured to concrete foundation reinforced to requirement.*



### SEGNALE SU PALI CON CORNICE POSTS-SIGN WITH FRAME

Segnale con spessore 20 mm con cornice perimetrale in estruso di alluminio collegata agli angoli da nodi a squadra in pressofusione di zama.

Superficie informativa con listelli in alluminio estruso h. 24, 36, 48, 72, 96, 144 mm, o con lamiera di alluminio sp. 1,2 mm nel caso di altezze maggiori di 144 mm.

Listelli e lamiere sono agganciati a scatto ad una piastra strutturale in alluminio estruso, non visibile dall'esterno, con clip in nylon a passo modulare che garantiscono la perfetta distanza tra i moduli.

Pali in alluminio estruso ad una via Ø 70 mm con sezione poligonale a 16 lati.

*Sign 20 mm thick with a perimeter frame in extruded aluminium joined together by Zamak die casting corners.*

*The information panel is made up of extruded aluminium strips, available in heights of 24, 36, 48, 72, 96 and 144 mm, or in aluminium sheet of 1.2 mm width if the sign is higher than 144 mm.*

*The strips and sheets are clipped to an invisible extruded aluminium structural plate, using a nylon clip with modular coupling that guarantees a perfect distance between the modules.*

*Extruded aluminium posts, single groove guide, Ø 70 mm, with 16-side polygonal section.*



## SEGNALE SU PALI POSTS-SIGN

Segnale con spessore 16 mm disponibile nelle altezze 100, 150, 200, 250, 300 mm.

Pali in alluminio estruso ad una via Ø 70 mm, con sezione poligonale a 16 lati, a due vie 55x80 mm.

Installazione su apposito dado di fondazione in cls opportunamente dimensionato.

*Sign 16 mm thick, available in heights of 100, 150, 200, 250 and 300 mm. Extruded aluminium posts, single groove guide, Ø 70 mm, with 16-side polygonal section; double groove guide model is 55x80 mm in size. Installation with hot zinc plated steel plates secured to concrete foundation reinforced to requirement.*

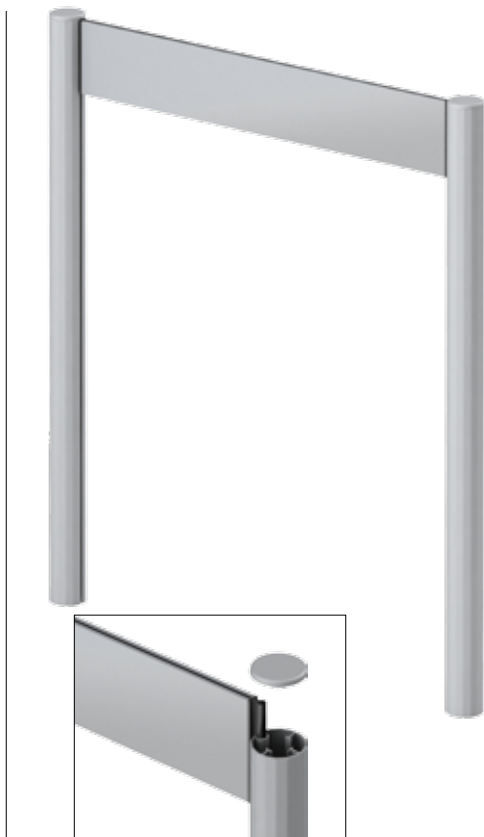

## SEGNALE A PARETE WALL SIGN

Segnale con spessore 15 mm con cornice perimetrale in estruso di alluminio collegata agli angoli da nodi a squadra in pressofusione di zama.

Superficie informativa con listelli in alluminio estruso h. 24, 36, 48, 72, 96, 144 mm, o con lamiera di alluminio sp. 1,2 mm nel caso di altezze maggiori di 144 mm.

Listelli e lamiere sono agganciati a scatto ad una piastra strutturale in alluminio estruso, non visibile dall'esterno, con clip in nylon a passo modulare che garantiscono la perfetta distanza tra i moduli.

Installazione con viti e tasselli ad espansione non in vista.

*Sign 15 mm thick with a perimeter frame in extruded aluminium joined together by Zamak die casting corners.*

*The information panel is made up of extruded aluminium strips, available in heights of 24, 36, 48, 72, 96 and 144 mm, or in aluminium sheet of 1.2 mm width if the sign is higher than 144 mm.*

*The strips and sheets are clipped to an invisible extruded aluminium structural plate, using a nylon clip with modular coupling that guarantees a perfect distance between the modules.*

*Installed with concealed screw anchors and bolts.*



**SEGNALE A PARETE CON "GESTIONE CARTA"**  
**WALL SIGN WITH PAPER INSERTS**

DIN A2 594x420 mm

DIN A3 420x297 mm

DIN A4 210x297 mm

Segnale con spessore 15 mm con cornice perimetrale in estruso di alluminio collegata agli angoli da nodi a squadra in pressofusione di zama.

Protezione in policarbonato trasparente spessore 2 mm con bordo perimetrale magnetico.

Installazione con viti e tasselli ad espansione non in vista.

*DIN A2 594x420 mm*

*DIN A3 420x297 mm*

*DIN A4 210x297 mm*

*Signs 15 mm thick with a perimeter frame in extruded aluminium joined together by Zamak die casting corners*

*Transparent polycarbonate protective cover, 2 mm thick, with magnetic perimeter edge.*

*Installed with concealed screw anchors and bolts.*



**SEGNALE A PARETE CON "GESTIONE CARTA" IN ABS**  
**WALL SIGN IN ABS WITH PAPER INSERTS**

150x150 mm

Segnale con spessore 15 mm stampato per iniezione in ABS UV resistente, con cornice perimetrale che si aggancia a scatto su una piastra di base.

Protezione in policarbonato trasparente spessore 2 mm.

Installazione con viti e tasselli ad espansione non in vista.

*150x150 mm*

*Sign 15 mm thick, injection moulded, ABS, UV resistant material, with a perimeter frame that click fastens on the base plate.*

*Transparent polycarbonate protective cover 2 mm thick.*

*Installed with concealed screw anchors and bolts.*



## SEGNALE A BANDIERA PROJECTING SIGN

Segnale con spessore 20 mm con cornice perimetrale in estruso di alluminio collegata agli angoli da nodi a squadra in pressofusione di zama.

Superficie informativa con listelli in alluminio estruso h. 24, 36, 48, 72, 96, 144 mm.

I listelli sono agganciati a scatto ad una piastra strutturale in alluminio estruso, non visibile dall'esterno, con clip in nylon a passo modulare che garantiscono la perfetta distanza tra i moduli.

Installazione con un profilo in alluminio estruso, fissato a parete con viti e tasselli ad espansione non in vista.

*Sign 20 mm thick with a perimeter frame in extruded aluminium joined together by Zamak die casting corners.*

*The information panel is made up of extruded aluminium strips, available in heights of 24, 36, 48, 72, 96 and 144 mm.*

*The strips are clipped to an invisible extruded aluminium structural plate, using a nylon clip with modular coupling that guarantees a perfect distance between the modules.*

*The installation has an extruded aluminium profile, fixed to the wall with concealed screw anchors and bolts.*



## SEGNALE SOSPESO HANGING SIGN

Segnale con spessore 20 mm con cornice perimetrale in estruso di alluminio collegata agli angoli da nodi a squadra in pressofusione di zama.

Superficie informativa con listelli in alluminio estruso h. 24, 36, 48, 72, 96, 144 mm.

I listelli sono agganciati a scatto ad una piastra strutturale in alluminio estruso, non visibile dall'esterno, con clip in nylon a passo modulare che garantiscono la perfetta distanza tra i moduli.

Installazione con filo d'acciaio e morsetto automatico cromato da fissare a soffitto.

*Sign 20 mm thick with a perimeter frame in extruded aluminium joined together by Zamak die casting corners.*

*The information panel is made up of extruded aluminium strips, available in heights of 24, 36, 48, 72, 96 and 144 mm.*

*The strips are clipped to an invisible extruded aluminium structural plate, using a nylon clip with modular coupling that guarantees a perfect distance between the modules.*

*Installed with steel thread and automatic chrome plated clamp to be fixed to the ceiling.*



### SEGNALE DA TAVOLO DESKTOP SIGN

Segnale con spessore 15 mm con cornice perimetrale, fissato su supporto inclinato in alluminio.

Superficie informativa con listelli in alluminio estruso h. 24, 36, 48, 72, 96, 144 mm, o con "gestione carta" nel formato 150x150 mm.

*Sign 15 mm thick with perimeter frame, fixed on triangular aluminium support.*

*The information panel is made up of extruded aluminium strips, available in heights of 24, 36, 48, 72, 96 and 144 mm or with paper inserts in a 150x150 mm format.*



### SEGNALE DA TAVOLO "TOBLERONE" DESKTOP SIGN "TOBLERONE"

È realizzato con un profilo estruso di alluminio a sezione triangolare, nel quale si inserisce a slitta su due lati il listello in alluminio estruso h. 36 mm. Tappi di chiusura in nylon stampato per iniezione.

*Realised with an extruded aluminium profile in triangular sections, in which the extruded aluminium panel, 36 mm high, is slid into place.*

*Closure with injection moulded nylon plugs*

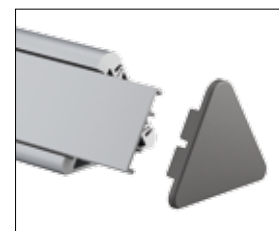

**SOSTEGNO PER SEGNALI AUTOSTABILI**  
**FREESTANDING SUPPORT**

È realizzato ad uno o due steli con un tubolare ovale in acciaio 40x20 mm di altezza variabile, collegato ad una base circolare in lamiera di acciaio. Il modello ad uno stelo è consigliato per segnali con larghezza massima 450 mm.

Realised with one or two posts with an oval tube in steel of 40x20 mm, with variable heights, connected to the circular base in steel sheet. The model with one post is recommended for signs no larger than 450 mm.

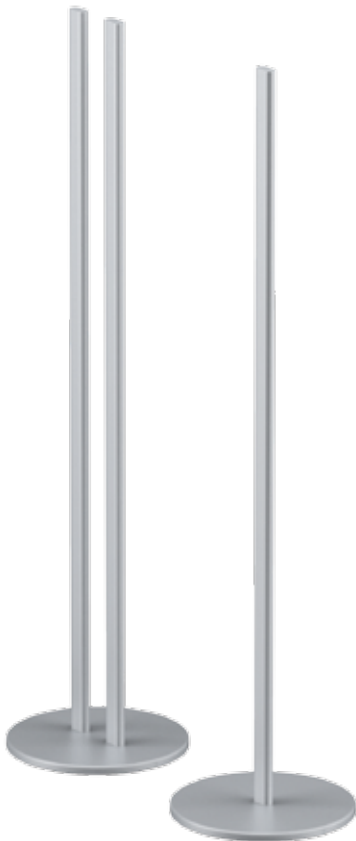

**BASE "FREESTANDING"**  
**"FREESTANDING" BASE**

È un sistema leggero e sicuro, utilizzato per rendere stabili pannelli di altezza massima 1900 mm con spessore da 5 a 25 mm.

Le due "ali" in alluminio estruso anodizzato argento che compongono la base, possono aprirsi e chiudersi, bloccando i pannelli nella corretta posizione verticale.

Tappi di chiusura laterali in ABS nero stampati per iniezione.

*A light and secure system, used to stabilise panels no more than 1900 mm high and 5 to 25 mm thick.*

*The two "wings" in silver anodised extruded aluminium that make up the base, can be opened and closed, retaining the panels in the correct vertical position.*

*Lateral closures with black injection moulded ABS plastic plugs.*



## DIMENSIONI DIMENSIONS

### TOTEM PER ESTERNI TOTEM FOR OUTDOOR USE

(HxB mm)			
Base 600	Base 750	Base 900	Base 1050
5000x600	5000x750	4500x900	4500x1050
4500x600	4500x750	4000x900	4000x1050
4000x600	4000x750	3500x900	3500x1050
3500x600	3500x750	3000x900	3000x1050
3000x600	3000x750	2500x900	2500x1050
2500x600	2500x750	2000x900	2000x1050
2000x600	2000x750		
Base 1200			
4000x1200			
3500x1200			
3000x1200			
2500x1200			
2000x1200			

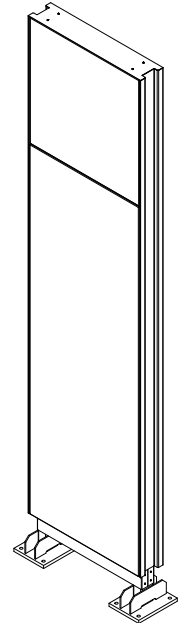

### SEGNALE SU PALI POSTS-SIGN

(HxB mm)			
Altezza-Height 100	Altezza-Height 150	Altezza-Height 200	Altezza-Height 250
100x600	150x600	200x600	250x600
100x750	150x750	200x750	250x750
100x900	150x900	200x900	250x900
100x1050	150x1050	200x1050	250x1050
100x1200	150x1200	200x1200	250x1200
100x1350	150x1350	200x1350	250x1350
100x1500	150x1500	200x1500	250x1500
Altezza-Height 300			
300x600			
300x750			
300x900			
300x1050			
300x1200			
300x1350			
300x1500			

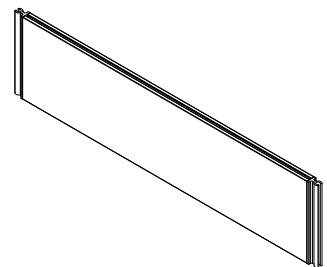



**SEGNALE SU PALI CON CORNICE**  
**POSTS-SIGN WITH FRAME**

<b>(HxB mm)</b>			
<b>Altezza-Height 100</b>	<b>Altezza-Height 150</b>	<b>Altezza-Height 200</b>	<b>Altezza-Height 300</b>
100x600	150x600	200x600	300x600
100x750	150x750	200x750	300x750
100x900	150x900	200x900	300x900
100x1050	150x1050	200x1050	300x1050
100x1200	150x1200	200x1200	300x1200
100x1350	150x1350	200x1350	300x1350
100x1500	150x1500	200x1500	300x1500
<b>Altezza-Height 400</b>	<b>Altezza-Height 450</b>	<b>Altezza-Height 500</b>	<b>Altezza-Height 600</b>
400x600	450x600	500x600	600x450
400x750	450x750	500x750	600x600
400x900	450x900	500x900	600x750
400x1050	450x1050	500x1050	600x900
400x1200	450x1200	500x1200	600x1050
400x1350	450x1350	500x1350	600x1200
400x1500	450x1500	500x1500	600x1350
			600x1500
<b>Altezza-Height 700</b>	<b>Altezza-Height 750</b>	<b>Altezza-Height 800</b>	<b>Altezza-Height 900</b>
700x600	750x600	800x600	900x600
700x750	750x750	800x750	900x750
700x900	750x900	800x900	900x900
700x1050	750x1050	800x1050	900x1050
700x1200	750x1200	800x1200	900x1200
700x1350	750x1350	800x1350	900x1350
700x1500	750x1500	800x1500	900x1500
<b>Altezza-Height 1000</b>	<b>Altezza-Height 1050</b>	<b>Altezza-Height 1200</b>	<b>Altezza-Height 1350</b>
1000x600	1050x600	1200x600	1350x900
1000x750	1050x750	1200x750	1350x1050
1000x900	1050x900	1200x900	1350x1200
1000x1050	1050x1050	1200x1050	1350x1350
1000x1200	1050x1200	1200x1200	1350x1500
1000x1350	1050x1350	1200x1350	
1000x1500	1050x1500	1200x1500	
<b>Altezza-Height 1500</b>			
1500x900			
1500x1050			
1500x1200			
1500x1350			
1500x1500			

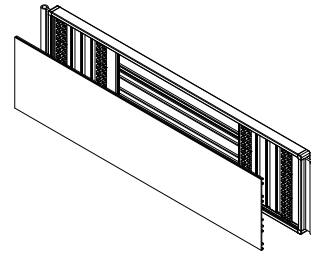

**PALO Ø 70 MM AD UNA VIA**  
**ONE SLOT POST Ø 70 MM**

<b>(H mm)</b>			
3250	2100	1600	1200
2400	1800	1400	

Piastra di fissaggio Ø 150 mm  
Fastening plate Ø 150 mm

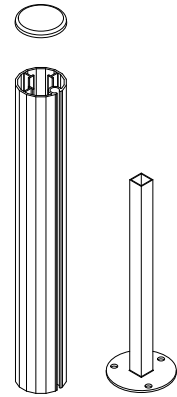

**PALO 55X80 MM A DUE VIE**  
**DOUBLE SLOT POST 55X80 MM**

<b>(H mm)</b>			
3250	2100	1600	1200
2400	1800	1400	

Piastra di fissaggio Ø 160 mm  
Fastening plate Ø 160 mm

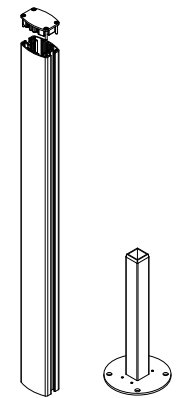

**SEGNALE A PARETE**  
**WALL SIGN**

<b>(HxB mm)</b>			
<b>Altezza-Height 100</b>	<b>Altezza-Height 150</b>	<b>Altezza-Height 200</b>	<b>Altezza-Height 300</b>
100x150	150x150	200x150	300x150
100x300	150x300	200x300	300x300
100x450	150x450	200x450	300x450
100x600	150x600	200x600	300x600
100x750	150x750	200x750	300x750
100x900	150x900	200x900	300x900
100x1050	150x1050	200x1050	300x1050
100x1200	150x1200	200x1200	300x1200
100x1350	150x1350	200x1350	300x1350
100x1500	150x1500	200x1500	300x1500
<b>Altezza-Height 400</b>	<b>Altezza-Height 450</b>	<b>Altezza-Height 500</b>	<b>Altezza-Height 600</b>
400x150	450x150	500x300	600x300
400x300	450x300	500x450	600x450
400x450	450x450	500x600	600x600
400x600	450x600	500x750	600x750
400x750	450x750	500x900	600x900
400x900	450x900	500x1050	600x1050
400x1050	450x1050	500x1200	600x1200
400x1200	450x1200	500x1350	600x1350
400x1350	450x1350	500x1500	600x1500
400x1500	450x1500		
<b>Altezza-Height 700</b>	<b>Altezza-Height 750</b>	<b>Altezza-Height 800</b>	<b>Altezza-Height 900</b>
700x450	750x450	800x450	900x450
700x600	750x600	800x600	900x600
700x750	750x750	800x750	900x750
700x900	750x900	800x900	900x900
700x1050	750x1050	800x1050	900x1050
700x1200	750x1200	800x1200	900x1200
700x1350	750x1350	800x1350	900x1350
700x1500	750x1500	800x1500	900x1500
<b>Altezza-Height 1000</b>	<b>Altezza-Height 1050</b>	<b>Altezza-Height 1200</b>	<b>Altezza-Height 1350</b>
1000x450	1050x450	1200x450	1350x450
1000x600	1050x600	1200x600	1350x600
1000x750	1050x750	1200x750	1350x750
1000x900	1050x900	1200x900	1350x900
1000x1050	1050x1050	1200x1050	1350x1050
1000x1200	1050x1200	1200x1200	1350x1200
1000x1350	1050x1350	1200x1350	1350x1350
1000x1500	1050x1500	1200x1500	1350x1500

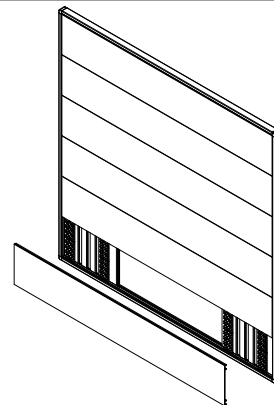

<b>(HxB mm)</b>			
<b>Altezza-Height 1500</b>	<b>Altezza-Height 1600</b>	<b>Altezza-Height 1800</b>	<b>Altezza-Height 1950</b>
1500x450	1600x600	1800x600	1950x600
1500x600	1600x750	1800x750	1950x750
1500x750	1600x900	1800x900	1950x900
1500x900	1600x1050	1800x1050	1950x1050
1500x1050	1600x1200	1800x1200	1950x1200
1500x1200	1600x1350	1800x1350	1950x1350
1500x1350	1600x1500	1800x1500	1950x1500
1500x1500			
<b>Altezza-Height 2100</b>			
2100x600			
2100x750			
2100x900			
2100x1050			
2100x1200			
2100x1350			
2100x1500			

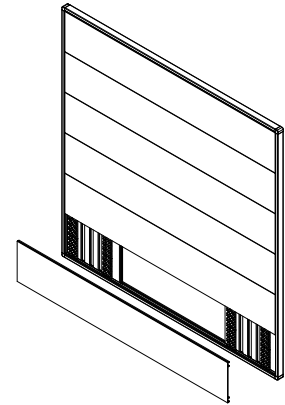

**SEGNALE A PARETE CON "GESTIONE CARTA"**  
**WALL SIGN WITH "PAPER INSERT"**

<b>(HxB mm)</b>	
150x150 in ABS - ABS made	DIN A3 420x297
DIN A4 297x210	DIN A2 594x420

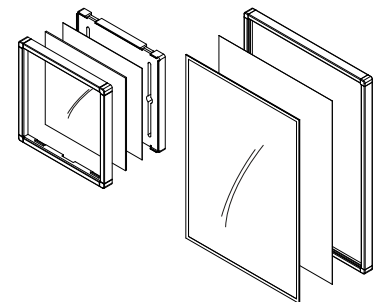

**SEGNALE A BANDIERA**  
**PROJECTING SIGN**

<b>(HxB mm)</b>			
<b>Altezza-Height 100</b>	<b>Altezza-Height 150</b>	<b>Altezza-Height 200</b>	<b>Altezza-Height 300</b>
100x150	150x150	200x150	300x150
100x300	150x300	200x300	300x300
100x450	150x450	200x450	300x450

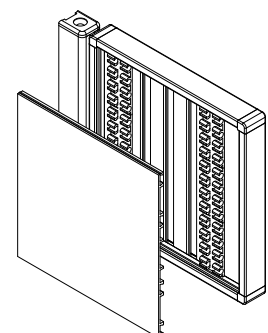

**SEGNALE SOSPESO**  
**HANGING SIGN**

<b>(HxB mm)</b>			
<b>Altezza-Height 100</b>	<b>Altezza-Height 150</b>	<b>Altezza-Height 200</b>	<b>Altezza-Height 300</b>
100x450	150x300	200x600	300x600
100x600	150x450	200x750	300x750
100x750	150x600	200x900	300x900
100x900	150x750	200x1050	300x1050
100x1050	150x900	200x1200	300x1200
100x1200	150x1050		
	150x1200		

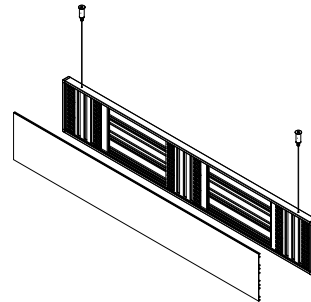

Kit con 2 morsetti automatici e 2 fili acciaio  
*Kit with 2 automatic clamps and 2 steel wires*



**SEGNALE DA TAVOLO**  
**DESKTOP SIGN**

<b>(HxB mm)</b>	
<b>Altezza-Height 100</b>	<b>Altezza-Height 150</b>
100x150	150x150
100x300	150x300

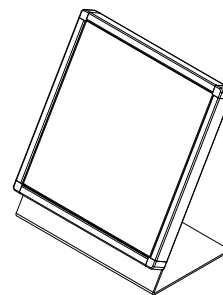

**SEGNALE DA TAVOLO "TOBLERONE"**  
**DESKTOP SIGN "TOBLERONE"**

<b>(HxB mm)</b>
50x200

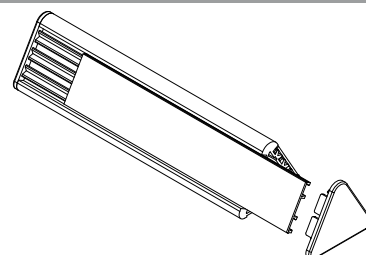

**SOSTEGNI PER SEGNALI AUTOSTABILI**  
**FREESTANDING SUPPORT**

**(HxØ mm)**

- 1 stelo h. 1300 / base Ø 325x25 mm  
*Single post support h. 1300 / base Ø 325x25 mm*
- 1 stelo h. 1400 / base Ø 325x25 mm  
*Single post support h. 1400 / base Ø 325x25 mm*
- 1 stelo h. 1600 / base Ø 325x25 mm  
*Single post support h. 1600 / base Ø 325x25 mm*
- 1 stelo h. 1800 / base Ø 400x25 mm  
*Single post support h. 1800 / base Ø 400x25 mm*
- 2 steli h. 1400 / base Ø 400x25 mm  
*Double post support h. 1400 / base Ø 400x25 mm*
- 2 steli h. 1600 / base Ø 400x25 mm  
*Double post support h. 1600 / base Ø 400x25 mm*
- 2 steli h. 1800 / base Ø 400x25 mm  
*Double post support h. 1800 / base Ø 400x25 mm*
- 2 steli h. 2000 / base Ø 400x25 mm  
*Double post support h. 2000 / base Ø 400x25 mm*

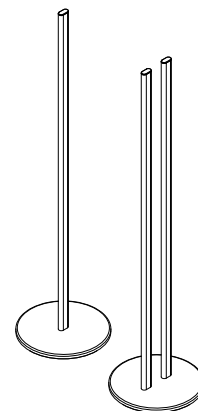

**BASE "FREESTANDING" PER SEGNALI CON ALTEZZA MASSIMA 1900 MM**  
**"FREESTANDING" BASE ONLY FOR SIGNS UNDER H. 1900 MM**

**(B mm)**

- 235
- 300
- 400
- 500

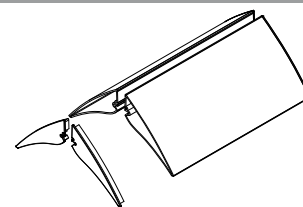

**LISTELLI IN ALLUMINO ESTRUSO**  
**EXTRUDED ALUMINIUM PROFILES**

<b>(HxB mm)</b>			
<b>Altezza-Height 24</b>	<b>Altezza-Height 36</b>	<b>Altezza-Height 48</b>	<b>Altezza-Height 72</b>
24x143 (150)	36x143 (150)	48x143 (150)	72x143 (150)
24x192 (200)	36x192 (200)	48x192 (200)	72x192 (200)
24x287 (300)	36x287 (300)	48x287 (300)	72x287 (300)
24x431 (450)	36x431 (450)	48x431 (450)	72x431 (450)
24x575 (600)	36x575 (600)	48x575 (600)	72x575 (600)
24x719 (750)	36x719 (750)	48x719 (750)	72x719 (750)
24x863 (900)	36x863 (900)	48x863 (900)	72x863 (900)
24x1007 (1050)	36x1007 (1050)	48x1007 (1050)	72x1007 (1050)
24x1151 (1200)	36x1151 (1200)	48x1151 (1200)	72x1151 (1200)
24x1295 (1350)	36x1295 (1350)	48x1295 (1350)	72x1295 (1350)
24x1439 (1500)	36x1439 (1500)	48x1439 (1500)	72x1439 (1500)
<b>Altezza-Height 96</b>	<b>Altezza-Height 144</b>		
96x143 (150)	144x143 (150)		
96x192 (200)	144x192 (200)		
96x287 (300)	144x287 (300)		
96x431 (450)	144x431 (450)		
96x575 (600)	144x575 (600)		
96x719 (750)	144x719 (750)		
96x863 (900)	144x863 (900)		
96x1007 (1050)	144x1007 (1050)		
96x1151 (1200)	144x1151 (1200)		
96x1295 (1350)	144x1295 (1350)		
96x1439 (1500)	144x1439 (1500)		

